



## X1 SERVER:

Visualization server for KNX standard system buildings

### Code:

**ILE-SRV-X1 (ESY / LTE / PRO)**



X1 server is a compact device to realize supervision and control systems for KNX standard systems, for mobile devices (iOS and Android smartphones and tablets) and fixed (PC and MAC). Through a dedicated configuration software it is possible to manage the control of lights, climate, blinds and shutters and energy of a modern KNX standard building which can be integrated with multimedia systems, video surveillance, intrusion detection and more. It is also possible to control via voice commands given to the Amazon and Google assistants.



## Description

X1 server is a dedicated device on which the Eve supervision system is installed. The product is designed for installation on a DIN rail and occupies 4 modules. The 5 Vdc power supply is external (power supply not included in the supply). The product with hardware based on an embedded operating system, has a KNX node and can therefore be connected directly to the bus network of KNX devices. It is also equipped with two RS485 ports for connecting slave-type Modbus RTU devices and an external USB port. External connectivity is achieved through the Ethernet port that connects the device directly to the router. The integrated web-server allows access to the device administration panel while configuration and commissioning are carried out through the use of the dedicated Eve Manager configuration software for fixed devices. The visualization environment, accessible with the dedicated Eve Remote app for smartphone and tablet mobile devices (iOS and Android) and for fixed devices (PC and Mac), can be fully customized according to one's taste, both in the graphic and organizational aspect of the intelligent system control interface.

## Versions and licenses

- ILE-SRV-X1-ESY: X1 server with EASY license version for system management with voice control (no visualization). Unlimited number of KNX group addresses / Unlimited acquisition of Modbus registers on RS485 from slave devices; Unlimited number of scenarios; Maximum number of logic functions: none; Maximum number of environments: none; Graphic interface styles: 0/2; Maximum number of users: 0.
- ILE-SRV-X1-LTE: X1 server with LITE license version for system management with voice control and dedicated app (visualization). Unlimited number of KNX group addresses / Unlimited acquisition of Modbus registers on RS485 from slave devices; Unlimited number of scenarios; Number of logic functions: none; Unlimited number of environments; Graphic interface styles: 1/2; Maximum number of users: 1 (multiple clients).
- ILE-SRV-X1-PRO: X1 server with PRO license version for system management with voice control and dedicated app (visualization). Unlimited number of manageable KNX group addresses; Unlimited acquisition of Modbus registers on RS485 from slave devices; Unlimited number of scenarios; Unlimited number of logic functions; Unlimited number of environments; Graphic interface styles: 2/2; Unlimited number of users (multiple clients).



**Note.** If the visualization to be set up requires a number of functions and / or protocols and / or systems greater than that supported by the purchased product, the following software license upgrades are available:

*ILE-UPG-X1-EL license upgrade from EASY to LITE*

*ILE-UPG-X1-LP license upgrade from LITE to PRO*

*ILE-UPG-X1-EP license upgrade from EASY to PRO*

## Main features

- 5 Vdc power supply by means of a special plug-in terminal supplied. Power supply not included.
- KNX bus (twisted pair) via red-black terminal provided
- 1 Ethernet port via cat. 5 or higher cable and standard RJ45 connector
- 2 RS485 ports for integration of Modbus RTU slave devices
- 1 USB 2.0 Type A port
- 9 frontal LEDs: POWER LED to signal the presence of power supply; SERVICE led to signal reception / transmission operations in progress for KNX bus, RS485 bus, Z-Wave

## Technical data

### Other features:

- Plastic housing
- Designed for mounting on a 35 mm profile rail (according to EN 60715)
- Degree of protection IP20 with product installed (according to EN 60529)
- Insulation class II (according to EN 60335-1)
- Climatic classification 3K5 (indoor, dry) and mechanical 3M2 (according to EN 50491-2)
- Device weight: 150 g

- 4 UM modular device (1 UM = 18 mm)
- Dimensions 72 x 90 x 63 mm (W x H x D)

**Environmental conditions:**

- Operating temperature: 0°C ... + 40°C
- Storage temperature: - 10 ... + 70°C
- Transport temperature: - 10 ... + 70°C
- Relative humidity: 95% non-condensing

**Operating, signaling and connection elements**

X1 server is equipped with status LEDs, terminals for power supply connection, KNX bus line, Ethernet network, RS485 bus line and a USB port.

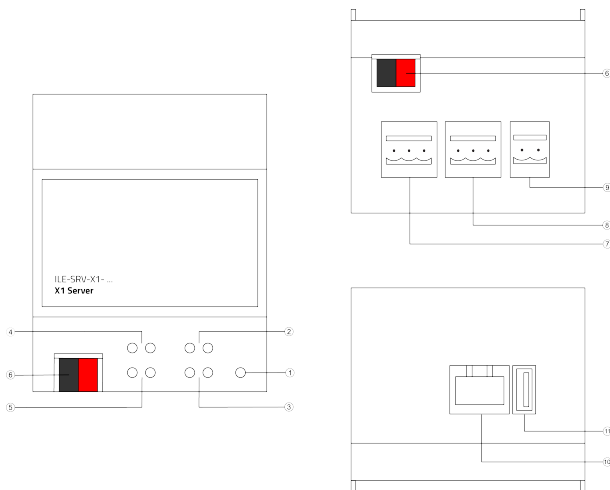

1. LED POWER
2. LED SERVICE RS485 (A)
3. LED SERVICE RS485 (B)
4. LED SERVICE KNX
5. LED SERVICE Z-WAVE
6. Clamp for KNX bus
7. Clamp RS485 bus (A)
8. Clamp RS485 bus (B)
9. Clamp for power-supply 5 Vdc
10. RJ45 Ethernet plug
11. USB port

**Signaling elements:**

- LED POWER: indicates the presence of 5 Vdc power supply at terminals
- LED SERVICE: YELLOW LED activates in fixed mode when in reception mode (RX), GREEN LED activates in fixed mode when in transmission mode (TX) for KNX, RS485 (A), RS485 (B) and Z-WAVE respectively

**Mounting**

The device has degree of protection IP20, and is therefore suitable for use in dry interior rooms. The housing is made for rail mounting according to EN 60715 in boards or cabinets for electrical distribution. The installation is in horizontal position, the correct position is when the KNX bus terminal is located at the bottom and the terminals for the outputs are located at the top. For the installation of the device on the rail proceed as follows:

- with the aid of a tool bring the locking device in the fully lowered position (1);
- place the upper edge of the rear inner profile on the upper edge of the rail (2);
- rotate the device towards the rail (3);
- push the locking device upward until it stops (4).

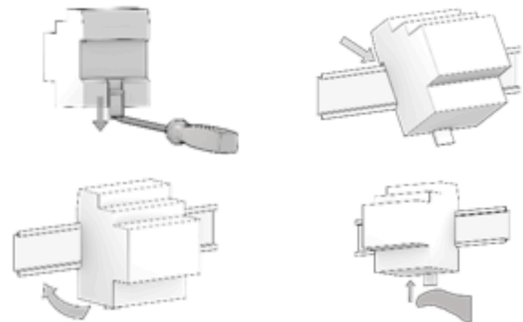

Before removing the device, be sure the inputs have been disconnected and the bus terminal has been extracted from its slot. Use a screwdriver to slide down the locking device and remove the device from the rail.



**Note.** It is recommended that the installation of the device always ensure the full accessibility of the front side to allow the led visualization.

**Power 5 Vdc**

The connection to the power supply is made via the screw terminals (1)+ and (2)- located on the removable 2-pin connector.

**Clamp characteristics:**

- Screw tightening of conductors
- Max. conductor cross-section 2.5 mm<sup>2</sup>
- Recommended conductor stripping approx. 6 mm
- Max. torque 0.5 Nm

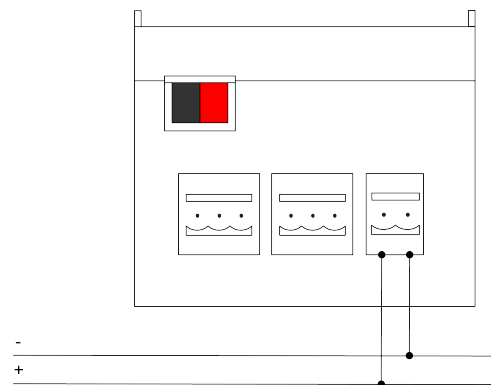

**Warning!** Il collegamento elettrico può essere eseguito esclusivamente da personale qualificato.

## Connection to the KNX bus network

The connection to the bus network is made via the KNX terminal included in the scope of delivery and inserted into the housing on the front of the device at the bottom.

### KNX clamp characteristics:

- Spring clamping of the conductors
- 4 conductor seats for each polarity
- Suitable for KNX bus cable with single conductors between 0.6 and 0.8 mm diameter
- Recommended conductor stripping approx. 5 mm
- Color coding: red = bus conductor + (positive), black = bus conductor - (negative)



**Warning!** Only use KNX bus power supplies (e.g. Ilevia ILE-KNX-A00-PS640) to supply the KNX bus lines. The use of other power supplies can impair communication and damage the devices connected to the bus.

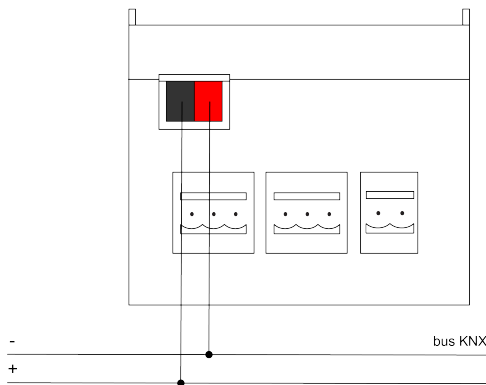

## Connection to RS485 bus

The connection to the RS485 bus network is made via the screw terminals (1) RT+ and (2) RT- located on the removable 2-pin connector.

### Clamp characteristics:

- Screw tightening of conductors
- Max. conductor cross-section 2.5 mm<sup>2</sup>
- Recommended conductor stripping approx. 6 mm
- Max. torque 0.5 Nm

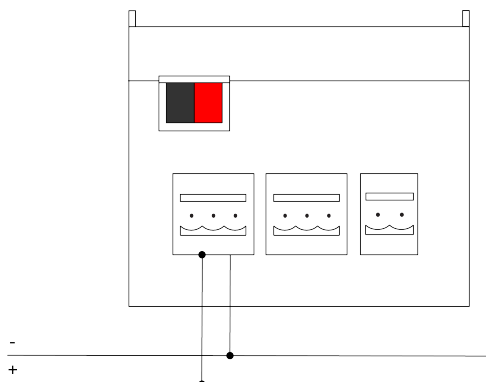

## Configuration and commissioning

The configuration of the network settings of the X1 server device must be done by accessing the web-server integrated in the product. The configuration of network settings other than factory settings (DHCP) must be carried out in accordance with the building automation system project created by a qualified professional.

### Network connection:

The configuration of the network settings of the Ilevia server requires a connection to the home network. Open an Internet browser and type <http://www.ilevia.com/evelocalip.php> in the address bar. Opening the browser at this address, a screen appears with a list of the IP addresses of all the Ilevia servers on the network. If there is only one server in the network, the login screen of the admin panel of the connected Ilevia server is shown.

In case of absence of a network during the installation phase, it is necessary to proceed as follows:

1. connect the X1 server to your PC via a “cross over” (or “crossover”) network cable
2. access your PC’s network settings, as illustrated in your operating system documentation
3. change the TCP/IP communication protocol settings (version 4) for the LAN port of your PC, and set the following parameters manually:
  - IP address: 192.168.1.200
  - Network mask: 255.255.255.0
  - Default gateway: 192.168.1.1
  - Save and wait for the new settings to take effect. If prompted, reboot the system.

When finished, open an Internet browser and type in the address bar:

**<http://192.168.1.100>**

### First access:

Opening the browser at the default address, the following login screen is offered:

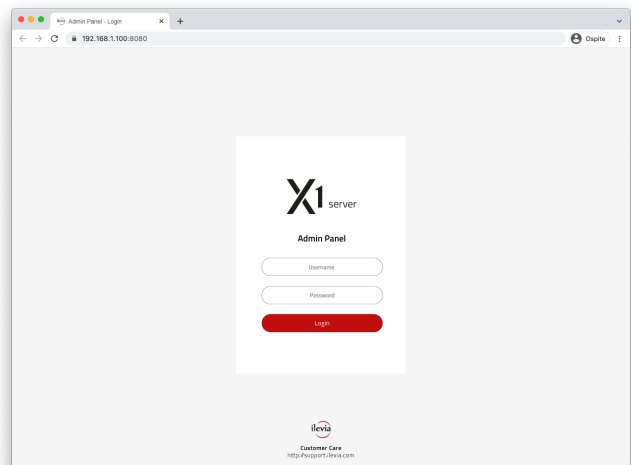

Enter the system default access data:

**Username: *admin***  
**Password: *password***

By doing so, you will have access to the main screen of the settings configuration environment of the X1 server device. Here you can change the server's network settings, login credentials and much more. At the end of the activity, to confirm the changes made on the page, press Reboot.

### Restore factory IP address

If necessary, it is possible to restore the factory IP address of Ilevia X1 server using a USB key (previously formatted) loaded with a preconfigured `.txt` file and modified according to the case.

1. Open the browser at this address <http://support.ilevia.com/x1-server/x1-server-ip-restore/> and download the latest version of the `eve.settings.txt` file
2. open the `eve.settings.txt` file, modify the configuration parameters as directed and save the changes
3. format a USB stick in FAT32 and copy the modified `eve.settings.txt` file into it
4. remove the USB key from the PC and then insert it into the USB port of the device
5. restart the server and wait at least 30 seconds before removing the USB stick

This procedure resets the IP address and retains all data relating to the configuration previously carried out on the automation system.

### Restore factory configuration

If the configuration made makes it impossible to access the server or its correct use, it is possible to restore the factory conditions by resetting the IP address and emptying the project using the same procedure used to restore the factory IP address. In this case, compared to what we saw previously, the procedure to follow is the following:

1. Open the browser at this address <http://support.ilevia.com/x1-server/x1-server-ip-restore/> and download the latest version of the `eve.settings.txt` file
2. open the `eve.settings.txt` file, modify the configuration parameters as directed and save the changes
3. open the Eve Manager configuration software and save a new empty project with the name `db.eve`
4. format a USB stick in FAT32 and copy the previously modified `eve.settings.txt` file and the empty `db.eve` file into it
5. remove the USB key from the PC and then insert it into the USB port of the device
6. restart the server and wait at least 30 seconds before removing the USB



**Warning!** To avoid losing all the configurations made for the automation project during a factory reset operation, it is recommended to make periodic backups of the supervision project.



The configuration and commissioning activities of the Ilevia X1 server device require specialized skills on the KNX network and knowledge of the specific automation project carried out with ETS. To acquire these skills, it is

essential to participate in the courses organized at KNX certified training centers. For further information: [www.knx.it](http://www.knx.it)

### Dimensions [mm]

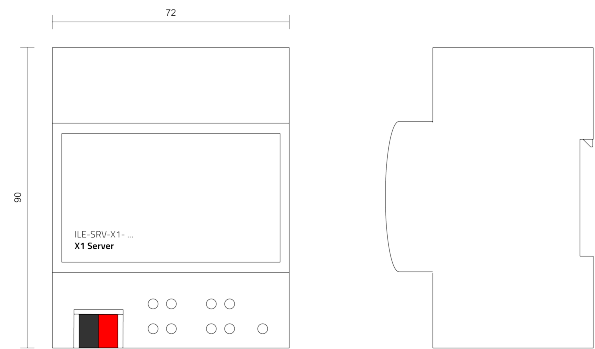

### Maintenance

The devices are maintenance-free. To clean them, use a dry cloth. The use of solvents or other aggressive substances is absolutely to be avoided.

### Disposal



The products described in this technical sheet at the end of its useful life are classified as waste from electronic equipment according to the European Directive 2012/19 / EU (RAEE recast), implemented in Italy with Legislative Decree no. 49 of 14 March 2014, and cannot be transferred to unsorted municipal solid waste.



**Important!** Incorrect disposal of the product can cause serious damage to the environment and human health. For correct disposal, inquire about the collection and treatment methods provided by the local authorities.

### Document

This technical sheet refers to the A3.0 release of Ilevia device cod. ILE-SRV-X1 (ESY/LTE/PRO) and is available for download on the website [support.ilevia.com](http://support.ilevia.com) in PDF (Portable Data Format).

File name	Release	Update
STILESrvX1_EN.pdf	A3.0	10 / 2021

### Warnings

- Installation, electrical connection, configuration and commissioning of the device may only be carried out by qualified personnel in accordance with the applicable technical regulations and the laws in force in the respective countries.
- The device may not be used in safety applications. However, the device may be used for auxiliary signaling functions.

- Opening the housing of the device results in the immediate interruption of the warranty period.
- In the event of tampering, compliance with the essential requirements of the applicable directives for which the device has been certified is no longer guaranteed.
- Defective Ilevia devices must be returned to the manufacturer at the following address: Ilevia S.r.l., Quartiere Prè 45 - 36061 Bassano del Grappa VI, Italia

#### **Other useful information**

- This technical data sheet is addressed to installers, system integrators and designers
- For more information on the product, you can contact Ilevia technical support at the e-mail address: support@ilevia.com or consult the website support.ilevia.com
- Each Ilevia device has a unique serial number on the label. The serial number can be used by installers and system integrators for documentation purposes and must be added to any communication addressed to Ilevia technical support in case of equipment malfunction.
- KNX® and ETS® are registered trademarks of KNX Association cvba, Brussels.

© Ilevia 2021. The company reserves the right to make changes to this technical documentation without notice.